

FSNF230-S US Technical Data Sheet

On/Off, Spring Return, 350°F [177°C] for half an hour, AC 230 V, 15 s Cycle Time



Technical Data

Power Supply	230 VAC, ±10%, 50/60 Hz
Power consumption in operation	27 VA
Power consumption in rest position	5 W, 9 VA (60 Hz 6.5 VA), End stop 55 VA, 0.25 A slow blow fuse *
Shaft Diameter	1/2...1.05" round, centers on 1/2" and 3/4" with insert, 1.05" without insert
Electrical Connection	18 GA, 3 ft [1 m], 3 color coded wires
Overload Protection	electronic throughout 0...95° rotation
Electrical Protection	grounded enclosure, 230 V
Angle of rotation	95°
Torque motor	70 in-lb [8 Nm] from 32...350°F [0...177°C]
Direction of motion motor	selectable by ccw/cw mounting
Direction of motion fail-safe	reversible with cw/ccw mounting
Position indication	Mechanical
Running Time (Motor)	15 s between 32...350°F [0...177°C], <15 s at rated voltage & torque
Running time fail-safe	15 s
Ambient humidity	max. 95% r.H., non-condensing
Ambient temperature	32...122°F [0...50°C]
Storage temperature	-40...176°F [-40...80°C]
Degree of Protection	IP40, NEMA 1
Housing material	galvanized steel
Gears	steel, permanently lubricated
Agency Listing	cULus listed to UL873 and CAN/CSA C22.2 No.24, UL 2043 Listed for air plenum installation per NEC 300.22 and IMC Section 602 NYC Department of Buildings MEA 197-07-M.California State Fire Marshal Listing 3210-1593:101.
Noise level, motor	45 dB(A)
Noise level, fail-safe	62 dB(A)
Servicing	maintenance-free
Quality Standard	ISO 9001
Weight	7.2 lb [3.3 kg]
Auxiliary switch	2 x SPDT, 7 A resistive (2.5 A inductive) @ AC 250 V, one set at 10°, one set at 85°

† UL File XAPX.E108966

Fire & Smoke damper actuator

Application

The type FSNF spring-return actuator is intended for the operation of smoke and combination fire and smoke dampers in ventilation and air-conditioning systems. The actuator will meet requirements of UL555 and UL555S when tested as an assembly with the damper and will meet requirements of UBC for 15 second opening and closing. Square footage of damper operated will depend on make and model and the temperature required.

Operation

Mounting of the actuator to the damper shaft or jackshaft (3/8" to 1.05") is via a cold-weld clamp. Teeth in the clamp and V-bolt dig into the metal of both solid and hollow shafts maintaining a perfect connection. The specially designed clamp will not crush hollow shafts. The bottom end of the actuator is held by an anti-rotation strap or by a stud provided by the damper manufacturer.

The actuator is mounted in its fail safe position with the damper blade(s) closed. Upon applying power, the actuator drives the damper to the open position. The internal spring is tensioned at the same time. If the power supply is interrupted, the spring moves the damper back to its fail-safe position.

Dimensions (Inches[mm])

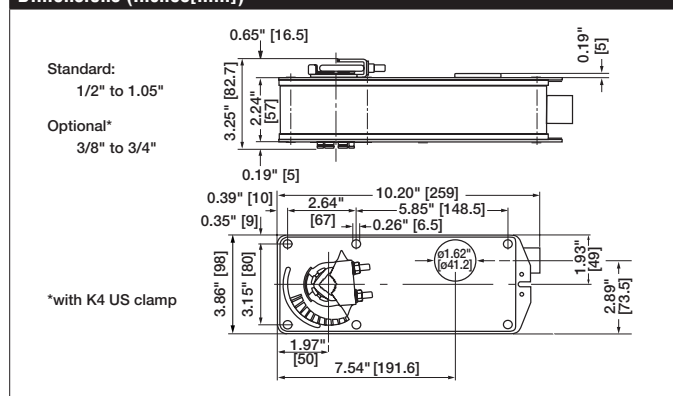

Safety Notes

* Neither UL nor Belimo require local over-current protection. The FSNF actuators draw higher peak current when driving against any type of stop. If used, this requires the value of a local fuse or breaker to be increased to avoid nuisance opening or tripping. A 2.5 A slow blow should be used for AC 24 V. A 0.5 A slow blow should be used for AC 120 V. A 0.25 A slow blow should be used for 230 V and a 0.3 A slow blow for AC 208 V. Transformers: Note that while a 24 V 100 VA transformer would handle 2 actuators, a 4 A breaker or plug fuse is insufficient. A 5 A slow blow would be required. Belimo Fire & Smoke actuators have passed the AMCA 520 and UL 555S Long Term Holding test. No special cycling is required during prolonged periods when actuator is driven open and held there. Periodic testing of dampers and actuators per local codes and NFPA 80 and NFPA 105 are required. The actuator contains no components which the user can replace or repair. A 1/2" threaded connector is standard. FSNFxx-FC models have a 3/8" Flex Connector. Other than the connector, these actuators are identical to the conduit connector version.

FSNF230-S US Technical Data Sheet

On/Off, Spring Return, 350°F [177°C] for half an hour, AC 230 V, 15 s Cycle Time







Accessories	
AF-P	Anti-rotation bracket AF/NF.
K4-1 US	Classic AF/NF jackshaft clamp (up to 1.05").
KH-AF-1 US	Classic AF/NF crankarm for Jackshaft to 1.05".
SH8	Push rod for KG6 & KG8 ball joints (36" L, 5/16" diameter).
ZDB-AF2 US	Angle of rotation limiter for Classic AF/NF.
ZG-100	Univ. right angle bracket 17"x11-1/8"x6" (HxWxbase).
ZG-101	Univ. right angle bracket 13x11x7-7/16" (HxWxbase).
ZG-AF US	Classic AF/NF crankarm adaptor kit.
ZG-AF108	Classic AF/NF crankarm adaptor kit with ZG-108.
ZG-DC1	Damper clip for damper blade, 3.5" width.
ZG-DC2	Damper clip for damper blade, 6" width.
ZS-100	Weather shield - galvaneal 13x8x6" (LxWxD).
ZS-150	Weather shield - PC w/ foam seal 16x8-3/8x4" (LxWxD).
ZS-260	Explosion proof housing.
ZS-300	NEMA 4X, 304 stainless steel enclosure.
BAE165 US	165° F electric thermal sensor, SPST, normally closed.
S2A-F US	Auxiliary switch, 2x SPDT, 3A (0.5A inductive) @250 VAC max.

Typical Specification

All smoke and combination fire and smoke dampers shall be provided with Belimo FSTF, FSLF, FSNF, or FSAF actuators. All substitutions must be approved before submission of bid. Damper and actuator shall have UL 555S Listing for 250°F (350°F). Actuator shall have been tested to UL 2043 per requirements of IMC 602.2 and NEC 300.22 (c). Where position indication is required -S models with auxiliary switches or damper blade switches will be provided per code requirements.

Wiring Diagrams

INSTALLATION NOTES

-  Provide overload protection and disconnect as required.
-  Actuators may be powered in parallel. Power consumption must be observed.
-  S4 makes to S6 when actuator is powered open.
-  Auxiliary switches are for end position indication or interlock control.
-  Double insulated.
-  Ground present on some models.

